

## Concealed grid MF curved ceiling system

Casoline **CURVE** is a lightweight non-loadbearing, suspended ceiling system for constructing curved ceiling and soffit linings. It can be used on convex or concave structures to achieve the required radii. The linings are simple to install and can be used in all types of buildings. Casoline **CURVE** is a non fire-rated system.







1 Gypframe MF7C Curved Support Channel / Gypframe MF8 Strap Hanger

### Key facts

- Can be used on concave or convex structures
- Minimum radii 600mm
- Uses pre-formed curved support channel
- No board pre-wetting required
- Durable linings
- Normal jointing techniques apply

## Components

### Gyproc and Glasroc products

			Take-off quantities <sup>1</sup>
	<b>Gyproc WallBoard</b>		100m <sup>2</sup>
	Thickness	9.5, 12.5, 15mm	
	Width	900mm	
	<b>Gyproc SoundBloc</b>		100m <sup>2</sup>
	Thickness	12.5, 15mm	
	Width	1200mm	
	<b>Glasroc MultiBoard</b>		100m <sup>2</sup>
	Thickness	6mm	
	Width	1200mm	



### Gypframe metal products

	<b>Gypframe MF5 Ceiling Section</b>		325m
	Main support section.		
	Prime dimensions	80mm x 26mm	
	Gauge	0.5mm	
	Length	3600mm	

<sup>1</sup> Quantities are for 100m<sup>2</sup> of regular shaped rectangular ceiling. Quantities are approximate, for a single layer installation with MF5 component at 300mm centres, and for guidance only, no allowance has been made for waste.











<sup>2</sup> Assuming drop in curve from 1m to 2m.

### Gypframe metal products

			Take-off quantities <sup>1</sup>
	<b>Gypframe MF6 Perimeter Channel</b>		Varies depending on ceiling perimeter
	Perimeter support for MF5's.		
	Prime dimensions	20mm x 27mm x 30mm	
	Gauge	0.5mm	
	Length	3600mm	
	<b>Gypframe MF7C<sup>3</sup> Curved Support Channel</b>		180m
	Primary support for MF5's.		
	Prime dimensions	15mm x 45mm	
	Gauge	0.9mm	
	Length	3600mm <sup>4</sup>	
	<b>Gypframe MF8 Strap Hanger<sup>2</sup></b>		300m
	Suspension of ceiling grid.		
	Prime dimension	25mm	
	Gauge	0.55mm	
	Length	25m (coil)	

<sup>3</sup> Supplied pre-formed to radii required and subject to special order.

<sup>4</sup> Gypframe MF7C curved support channel of between 600mm and 1000mm are supplied in lengths of 2000mm

Gypframe metal products		Take-off quantities <sup>1</sup>	Fixing and finishing products		Take-off quantities <sup>1</sup>	
	<b>Gypframe GA1 Steel Angle<sup>2</sup></b>	300m		<b>Gyproc Wafer Head Drywall Screws</b>	as required	
	Width			25mm x 25mm		For metal-to-metal fixing up to 0.79mm thick.
	Gauge			0.55mm		
	Length	2900mm				
	<b>Gypframe MF11 Nut and Bolt</b>	100		<b>Gyproc Wafer Head Jack-Point Screws</b>	as required	
	Joining hanger to soffit cleat.			For fixing hanger to Gypframe MF7.		
	<b>Gypframe MF12 Soffit Cleat</b>	100		<b>Gyproc Sealant</b>	1 cartridge per 35m based on a 6 - 10mm bead	
	Suspension point from structural soffit.					Sealing airpaths to achieve optimum sound insulation.
	Prime dimensions			27mm x 37mm x 25mm		
	Gauge	1.6mm		<b>Gyproc jointing materials</b>	as required	
				For seamless jointing.		
Fixing and finishing products				<b>Thistle Multi-Finish or Thistle Board Finish</b>	10m <sup>2</sup> for 25kg bag	
	<b>Gyproc Drywall Screws</b>	1250		To provide a plaster skim finish.		
	For fixing boards to stud framing up to 0.79mm thick.				<b>Thistle Spray Finish</b>	11m <sup>2</sup> for 25kg bag
				Gypsum finish plaster for spray or hand application.		

## Construction tips

- The following points should be considered in addition to the general planning guidance given in **CasoLine MF**
- Estimated construction time  $1\text{m}^2 - 1.5\text{m}^2 / \text{man hour}$  (single layer ceiling) or  $0.5\text{m}^2 - 1\text{m}^2 / \text{man hour}$  (double layer ceiling) ready for finishing
- Board joints should be avoided on the apex of a convex curve for the exposed layer of board. Gypframe MF5 Ceiling Section positions, therefore, should be pre-determined at the design stage
- Consider the degree of curvature required. The minimum radius will be influenced by the board characteristics, the length of curve, the support centres, and the occurrence of board joints (see **Table 1**)
- For installation of Artec Gyptone and Artec Rigitone boards refer to the British Gypsum Ceilings Installation Guide
- Where the radius is greater than 3000mm, standard **CasoLine MF** procedures apply

Table 1 - Minimum radii and framing centres

Board type	Thickness mm	Minimum radius <sup>1</sup> mm	MF5 <sup>3</sup> centres mm	Span (suspension points) of MF7C <sup>4</sup> mm	MF7C <sup>4</sup> centres mm
Glasroc MultiBoard	6	600	300	900	1200
	12 (2 x 6)	600	300	600	1200
Gyptone QUATTRO 41	12.5	6000	300	900	1200
Gyptone QUATTRO 45	12.5	6000	300	900	1200
Gyptone QUATTRO 46	12.5	6000	300	900	1200
Gyptone QUATTRO 47	12.5	6000	300	900	1200
Gyptone LINE 6	12.5	6000	300	900	1200
Gyptone LINE 7 Curve	6.5	1200	300	1200	1200
Gyptone BASE Curve <sup>2</sup>	6.5	1200	300	1200	1200
Rigitone boards (all)	12.5	5000	330	900	1000
Gyproc WallBoard	9.5	1800	300	750	1200
	12.5	3600	300	600	1200
	15	4800	300	600	1200
Gyproc SoundBloc	12.5	2900	300	600	1200
	15	3600	300	600	1200
Gyproc FireLine	12.5	4800	300	600	1200
	15	5700	300	600	1200

<sup>1</sup> Concave or convex.

<sup>2</sup> Gyptone BASE Curve board is used in conjunction with Gyptone LINE 7 Curve to create non-perforated areas, e.g. around perimeters.

<sup>3</sup> Gyprframe MF5 Ceiling Section.

<sup>4</sup> Gyprframe MF7C Primary Support Channel.

**NB** It is not possible to bend Rigidur H board.

## Installation



### Suspension from concrete soffit

Install CasoLine CURVE ceiling as per CasoLine MF with the following exceptions. Because of the nature of this method of construction, it may be necessary for detail to be evolved on-site. It is important to ensure that the frame to which this board is to be fixed is reasonably rigid.



1

- Mark lines on the perimeter to the curvature required.
- Cut and fix Gypframe MF6 Perimeter Channel to the perimeter following the line of the curve.

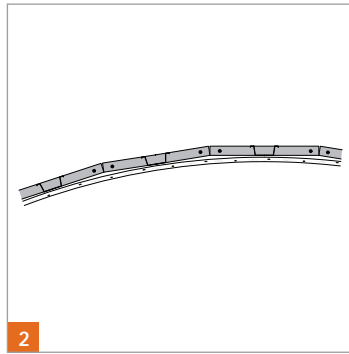

2

- Insert screws either side of the cut Gypframe MF6 Perimeter Channel and at intervals in between (if required) to achieve 300mm maximum fixing centres.

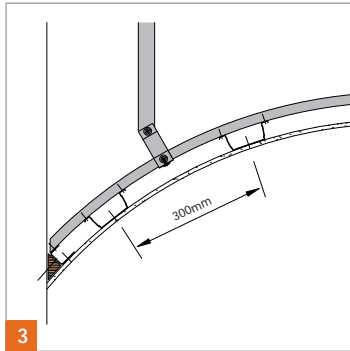

- Where the curved ceiling abuts the wall, a timber fillet is required.

**NB** In any event the termination of any curved sections must be stabilised to ensure the ceiling framework is rigid prior to board fixing.



- Fix the Gypframe MF12 Soffit Cleats to the structure at the support centres shown in Table 1 on the line of the Gypframe MF7C Curved Support Channel sections, which are fixed at 1200mm centres. The Gypframe MF12 Soffit Cleat centres are closer than normal to take account of the curvature of the Gypframe MF7C section (see Junction details).

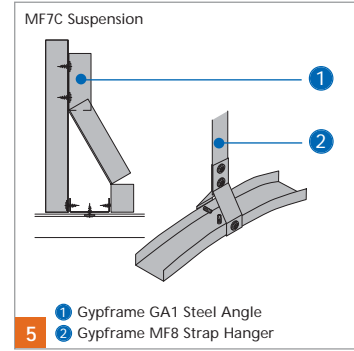

- Drop Gypframe MF8 Strap Hanger or Gypframe GA1 Steel Angle and connect to the Gypframe MF7C. Adopt one of the alternative methods shown above.

- Fix hangers directly to the side of joists using two Gyproc Drywall Timber Screws spaced 25mm apart. The lower fixing should be 25mm **minimum** from the bottom of the joist.

**NB** Suspension from timber joists

The procedure is as for concrete, except that MF12 Soffit Cleats are not required.





6

- If strap is used, it is important to pre-bend it to ensure a snug fit around the Gyproframe MF7C. If the connection occurs on a steeply curving Gyproframe MF7C section, consider forming the connection 'stirrup' separately from the hanger to enable a vertical drop. See Figure 3.

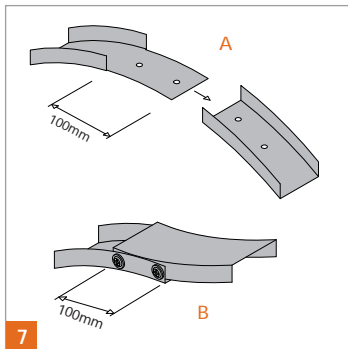

7

- Join lengths of Gyproframe MF7C by cutting back the flanges on one section and overlapping by 100mm. Secure using two Gyproc Wafer Head Jack-Point Drywall Screws (see Figure 7 option A above). At changes in the direction of curvature install two fixings through each flange (see Figure 7 option B above).

**!** A hanger is required at Gyproframe MF7C junction positions.



8

- Fix Gyproframe MF5 Ceiling Section to the underside of the Gyproframe MF7C at 300mm centres using two Gyproc Wafer Head Jack-Point Drywall Screws. See Figures 9 & 10.

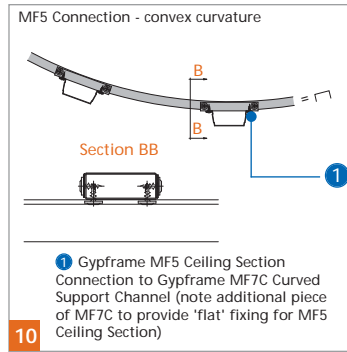
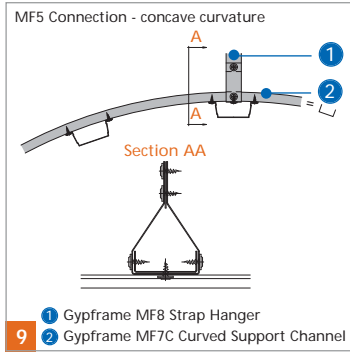

- If the Gypframe MF7C is installed with legs down, a small section of Gypframe MF7C is fixed to bridge the flanges to provide a flat, positive fixing for the Gypframe MF5 positions. Secure the small Gypframe MF7C sections with two Gyproc Wafer Head Jack-Point Drywall Screws through each flange. See Figure 10.



### Board fixing - single layer

- Select the board option to give the curvature required (see **Table 1**).
- Fix boards with their long edges at right angles to the Gypframe MF5 Ceiling Sections. Stagger board joints and avoid joints occurring on the apex of a convex curve otherwise problems may be encountered when finishing.
- Insert fixings no closer than 10mm from bound board edges and 13mm from cut edges.

- Insert Gyproc Drywall Screws at 230mm centres to all supports in the field of the board and at 150mm centres at board ends.

**NB** Select screw lengths to give nominal 10mm penetration into the steel.

### Board fixing - double layer

- Select the board option to give the curvature required (see **Table 1**).
- Fix the inner layer boards as for 'Board fixing - single layer', previously.
- Fix outer layer boards at 230mm centres to all supports in the field of the board and 150mm centres at board ends, with joints staggered in relation to the first layer. Avoid board joints occurring in the outer layer of boards on the apex of the curve.

## Junction details

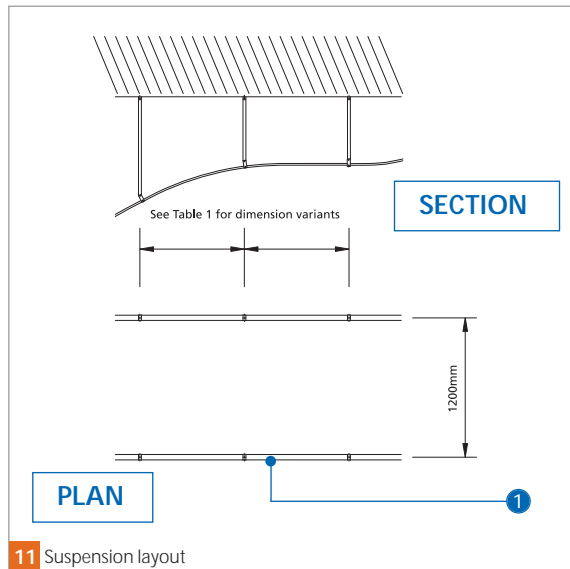

**NB** Select screw lengths to give nominal 10mm penetration into the steel.

**NB** Board fixing Arteco Gyptone and Arteco Rigitone refer to British Gypsum Ceilings Installation Guide. ([www.british-gypsum.com](http://www.british-gypsum.com))

**NB** Whilst good finishing can be achieved using normal jointing techniques, a plaster skim finish may be considered (with the exception of Gyptone boards), particularly where there are a number of butt end joints to the curve

1 Gypframe MF7C Curved Support Channel