

Concealed grid ceiling lining system

GypLyner UNIVERSAL ceiling is a general purpose ceiling lining system suitable for most internal applications. It is used in all types of buildings, from residential properties to large commercial developments, and is equally suited to both new-build and refurbishment. The system is compatible with, and uses common components of, GypLyner UNIVERSAL wall lining and GypLyner ENCASE steel encasement systems.





- 1 Gypframe GL1 Lining Channel + Gypframe GL5 or GL6 Timber Connector
- 2 Gypframe GL1 Lining Channel + Gypframe GL2, GL9 or GL12 Bracket

Key facts

- General purpose and versatile ceiling lining
- Suitable for concrete soffits or timber joists
- Seamless lining surface
- Ceiling void accommodates small service routings
- Stand-off can be adjusted
- Commonality of ceiling and wall lining components





Components

Gyproc and Glasroc board products

			Take-off quantities ¹
	Gyproc WallBoard^{2,3}	Thickness 12.5, 15mm Width 900, 1200mm	100m ²
	Gyproc SoundBloc²	Thickness 12.5, 15mm Width 1200mm	100m ²
	Gyproc FireLine^{2,3}	Thickness 12.5, 15mm Width 900, 1200mm	100m ²
	Gyproc Plank	Thickness 19mm Width 600mm	100m ²
	Glasroc MultiBoard	Thickness 12.5mm Width 1200mm	100m ²



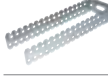

¹ Quantities are for 100m² of regular shaped rectangular ceiling. Quantities are approximate for a single layer installation with Gyproframe GL1 Lining Channels at 450mm centres. Quantities are for guidance only, no allowance has been made for waste. Refer to section 11 – Quantity take-off details.

Gyproframe metal products

			Take-off quantities ¹
	Gyproframe GL1 Lining Channel	Length 2400, 2700, 3000, 3600mm	230m
	Gyproframe GL2 Bracket	For fixing to concrete or masonry structure. Length 195mm flat (max 75mm stand-off from structure)	240
	Gyproframe GL9 Bracket	Length 295mm flat (max 125mm stand-off from structure)	240
	Gyproframe GL12 Bracket	Length 395mm flat (max 175mm stand-off from structure)	240
	Gyproframe GL3 Channel Connector	For joining GL1 Lining Channels.	93
	Gyproframe GL5 Timber Connector	Maximum 35mm drop. Length 70mm	240

² Moisture resistant boards are specified in intermittent wet use areas e.g. shower cubicles.



³ Also available in DUPLEX grades where vapour control is required.

Gypframe metal products		Take-off quantities ¹
	Gypframe GL6 Timber Connector Maximum 120mm drop. Length 170mm	240
	Gypframe GL8 Track Length 3600mm	Subject to ceiling perimeter
Fixing and finishing products		
	Gyproc Proflex Access Panels For access to the plenum for maintenance purposes.	As required
	Gyproc Wafer Head Drywall Screws For metal-to-metal fixing up to 0.79mm thick.	500

Fixing and finishing products		Take-off quantities ¹
	Gyproc Drywall Timber Screws For fixing timber connectors to timber supports.	2 per connector
	Gypframe GL11 GypLyner Anchors For fixing GL2 or GL9 Brackets to concrete / masonry.	1 per bracket (if specified)
	Gyproc Drywall Screws For fixing boards to stud framing up to 0.79mm thick.	1800
	Gyproc Sealant Sealing air paths for optimum sound insulation.	1 cartridge per 35m based on 6-10mm bead
	Gyproc jointing materials For a seamless finish.	As required

Components

Fixing and finishing products

		Take-off quantities ¹
	Thistle Board Finish or Thistle Multi-Finish To provide a plaster skim finish.	10m ² per 25kg bag
	Isover General Purpose Roll For providing acoustic / thermal insulation.	As required
	or Isover APR 1200 For enhanced acoustic performance.	As required

¹ Quantities are for 100m² of regular shaped rectangular ceiling. Quantities are approximate for a single layer installation with Gypframe GL1 Lining Channels at 450mm centres. Quantities are for guidance only, no allowance has been made for waste. Refer to section 11 – Quantity take-off details.

Construction tips

- Estimated construction time 3m² / man hour (single layer ceiling) or 2m² - 2.5m² / man hour (double layer ceiling) - ready for finishing
- For concrete soffits allow for a stand-off of 25mm-75mm plus lining thickness using Gypframe GL2 Brackets, 25mm-125mm plus lining thickness using Gypframe GL9 Brackets, and 25mm-175mm plus lining thickness using Gypframe GL12 Brackets
- For timber joists using Gypframe GL5 or GL6 Timber Connectors, allow for a maximum cavity depth of 35mm and 120mm respectively (measured from the bottom of the joists to the underside of the lining)
- Gypframe GL11 GypLyner Anchors are recommended for fixing brackets to solid concrete and masonry
- Seal all gaps at the perimeter of the ceiling and any small air paths with Gyproc Sealant to maintain airtightness and optimum sound insulation
- Recommended board size is 900mm x 1800mm - if longer boards are specified, lift and hold against the ceiling using a Gyproc Projack or Gyproc Board Lift
- To reduce the risk of interstitial condensation install a vapour control layer using DUPLEX grade board
- Predetermine the position of fixtures and fittings with supplementary framing, and use Gyproc Profiflex Access Panels at key access points

Installation - concrete soffit

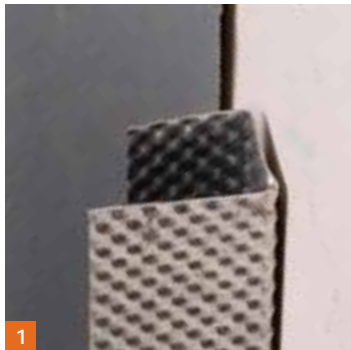

- Determine the required ceiling level and mark the position of Gypframe GL8 Track.
- Fix Gypframe GL8 Track with the longer leg at the bottom, at 600mm centres using suitable fixings.
- Mark lines on the soffit to determine the GypLyner bracket positions. Position the lines at 450mm intervals (12.5mm linings) or 600mm intervals (15mm linings).



- Fix brackets at 1200mm maximum centres. Position each bracket, fold down one leg and fix through bracket slot to the soffit using a Gypframe GL11 GypLyner Anchor. Mark protruding leg of each bracket to indicate the fixing level of the Gypframe GL1 Lining Channel.
- NB** Select Gypframe GL2 Bracket for stand-offs between 25mm and 75mm; Gypframe GL9 Bracket for stand-offs between 25mm and 125mm; or Gypframe GL12 Bracket for stand-offs between 25mm and 175mm.



- Locate Gypframe GL1 Lining Channel into the perimeter track.



- Position the channel, bend down the other leg of each bracket in turn and screw-fix each leg to the channel using Gyproc Wafer Head Drywall Screws.

NB Ensure that the channel is level before fixing.



- Bend back the protruding leg of each bracket to sit back from the channel face.



- Extend channel sections, where required, by engaging channel ends over a Gyproframe GL3 Channel Connector.

Fixtures

- Install any additional channel or supplementary framing as required to support fixtures and fittings.



Board fixing

- Screw-fix board to supports with long edges at right angles to the framing.
- Lightly butt board ends and insert fixings no closer than 10mm from bound edges and 13mm from cut edges. Stagger end joints.
- Insert Gyproc Drywall Screws at 230mm maximum centres in the field of the boards, and 150mm maximum centres at board ends.

- For double layer linings stagger board joints in the second layer relative to the first.

NB Select Gyproc Drywall Screws to provide a nominal 10mm penetration into the framing (dependent on board thickness).

Installation - timber joists

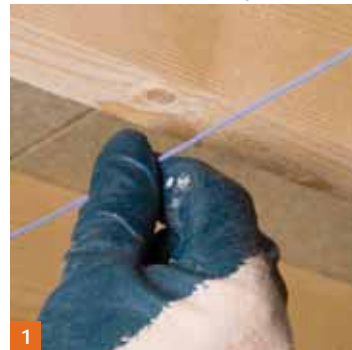

- Determine the required ceiling level, mark and fix Gypframe GL8 Track at perimeter as for concrete soffits.
- Mark lines beneath the joists to determine the timber connector fixing positions. Position lines at 450mm intervals (12.5mm linings) or 600mm intervals (15mm linings).

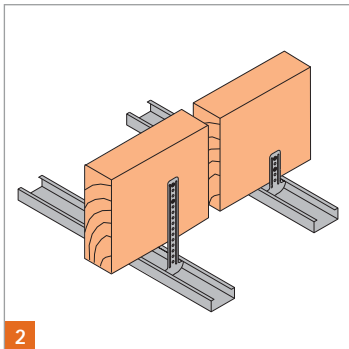

- Fix timber connectors at 1200mm maximum centres for single layer plasterboard specifications and maximum 600mm centres for double layer. Fix each timber connector to the side of a joist using two Gyproc Drywall Timber Screws.

NB Allow one hole between fixings for Gypframe GL5 Timber Connector; two holes between fixings for Gypframe GL6 Timber Connector. Align accurately since the connectors cannot be adjusted once fixed.



- Engage one side of the Gypframe GL1 Lining Channel into a row of timber connectors and twist into position.
- Push the channel to locate into the perimeter track.
- Extend channel sections, where required, by engaging channel ends over a Gypframe GL3 Channel Timber Connector (see Construction detail 6).

Board fixing

- Fix board to supports as for concrete soffits but ensure that board edge joints do not coincide with the position of timber connectors.

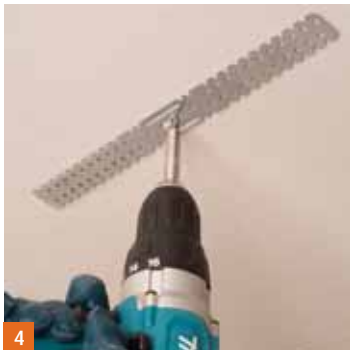

Existing ceiling

- If the existing ceiling is to be retained, Gypframe GL2, GL9 or GL12 Brackets are fixed to joists through the retained ceiling with suitable fixings and washers. Gypframe GL1 Lining Channels and boards are fixed to form the new ceiling.

Construction details

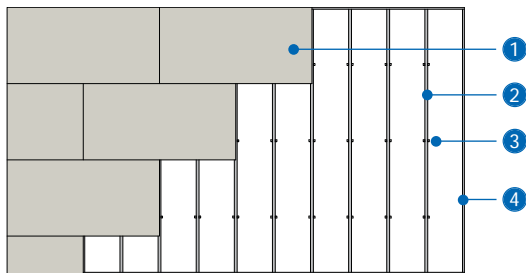

5 Reflected ceiling plan for concrete soffit - single layer 15mm Gyproc plasterboard with channels at 600mm maximum centres (or 12.5mm Gyproc plasterboard with channels at 450mm maximum centres)

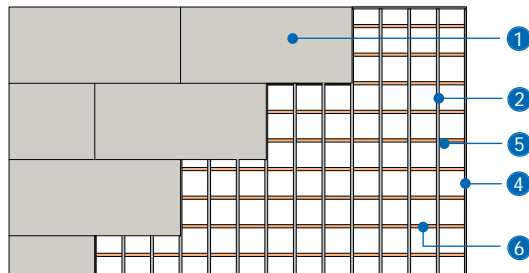

6 Reflected ceiling plan for timber joist floor - single layer 12.5mm Gyproc plasterboard with channels at 450mm maximum centres (or 15mm Gyproc plasterboard with channels at 600mm maximum centres)

- | | |
|-------------------------------------|--|
| 1 Gyproc plasterboard | 4 Gypframe GL8 Track |
| 2 Gypframe GL1 Lining Channel | 5 Gypframe GL5 or GL6 Timber Connector |
| 3 Gypframe GL2, GL9 or GL12 Bracket | 6 Timber joist floor |